

## GS PRO 30S4 950X525

Heavy loads hand pallet truck (3.000 kg)



### LIFTER GS PRO 30

Extremely tough and resistant hand pallet truck for heavy duty applications, with lifting capacity up to 3.000 kg.



### REINFORCED STRUCTURE

Steel bars welded under the forks, solid tie-rod as well as a base with thick metal sheet allow the GS 30 to easily handle the heaviest loads.



### HYDRAULIC UNIT

Resistant and reliable one piece cast iron pump, worked with numerical control machine, including:

- **MAXIMUM PRESSURE VALVE:** safety device that ensures the transpallet against overloads. When the pressure inside the hydraulic circuit exceeds the set calibration value according to the maximum nominal flow, the valve automatically locks the forks.
- **PROPORTIONAL LOWERING VALVE:** lowering speed can be proportionally controlled according to the lever position on the tiller. Perfect working tool to carry fragile and delicate loads like crystal, glass and ceramics.



### VARNISHING

Following an appropriate conditioning operation the frame is varnished with polyester powder at a temperature of 250° to guarantee maximum resistance to wear and atmospheric agents.

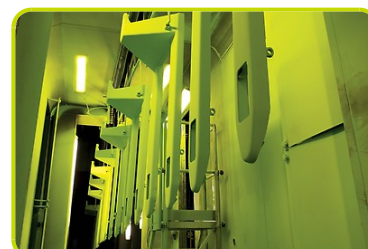

## STANDARD CONFIGURATION

- Nylon - Poly 55 steering wheels
- Nylon rollers
- 4 Curves handle with all the controls (lowering / drive position / lifting) available in a single lever for simple and safe control



- Entry/exit rollers. Supplementary rollers to allow easier entrance and quicker exit from a closed pallet, reducing the impact on the main rollers and guaranteeing a longer life.



## OPTIONAL CONFIGURATION

- Nylon steering wheels
- Aluminium - Poly steering wheels
- Aluminium - Rubber steering wheels



- Polyurethane rollers



- 4 Curves ergonomic handle. The soft rubber covering aids operator comfort and helps to reduce vibration, enabling a more comfortable and secure grip.



- Manual control brake. The brake of the pallet truck, available with rubber steering wheels, is adjustable through the tiller lever to ensure safe use on slopes and ramps. The locking function makes it possible to park the pallet truck even on slopes without rolling away.



- Quick lift. The perfect tool to lift quicker your loads up to 150 kg. The hydraulic pump is specifically engineered to cut job time and increase efficiency. It takes just 6 strokes to raise a pallet to full height, instead of 13 with the traditional HPT.



## Описание

1.1 Изготовитель		LIFTER
1.3 ПРИВОД		ручной
1.4 ТИП УПРАВЛЕНИЯ		Ручной
1.5 Грузоподъемность	Q Kg	3000
1.6 РАССТОЯНИЕ ДО ЦЕНТРА ТЯЖЕСТИ ГРУЗА	c mm	475
1.8 Расстояние от оси роликов до основания вил	x mm	732
1.9 КОЛЕСНАЯ БАЗА	y mm	992

## Вес

2.1 ВЕС ТЕЛЕЖКИ В СБОРЕ (БЕЗ ГРУЗА)	Kg	80
2.2 НАГРУЗКА НА ОСИ ПОД ГРУЗОМ, ЗАДНЯЯ ОСЬ	Kg	2254
2.2 НАГРУЗКА НА ОСИ ПОД ГРУЗОМ, ПЕРЕДНЯЯ	Kg	826
2.3 НАГРУЗКА НА ОСИ БЕЗ ГРУЗА, ЗАДНЯЯ ОСЬ	Kg	29
2.3 НАГРУЗКА НА ОСИ БЕЗ ГРУЗА, ПЕРЕДНЯЯ	Kg	51

## ШАССИ/КОЛЕСА

3.1 Передние колеса		POLY.I./ NYLON
3.1 Задние Колеса		NYLON
3.2 Размеры Передних Колес (Ø)	mm	200
3.2 Размеры Передних Колес (Ширина)	mm	55
3.3 Размеры Задних Колес (Ø)	mm	82
3.3 Размеры Задних Колес (Ширина)	mm	60
3.5 Размер шины: задние колеса	nr	4
3.5 Rear balancing axle		No
3.6 Колея, Передние Колеса	b10 mm	155
3.7 Колея, Задние Колеса	b11 mm	375

## Габариты

4.4 Высота Подъема	h3 mm	115
4.9 Макс. высота ручки при движении	h14 mm	1160
4.15 Высота Вил В Опущенном Положении	h13 mm	85
4.19 Общая Длина Тележки	l1 mm	1350
4.20 Расстояние До Основания Вил	l2 mm	400
4.21 Общая Ширина Тележки	b1 mm	525
4.22 Размеры Вил	s mm	50
4.22 Размеры Вил	e mm	150
4.22 Размеры Вил	l mm	950
4.25 Расстояние Между Вилами (По Наружному Краю)	b5 mm	525
4.32 Клиренс, В Центре Колесной Базы	m2 mm	35
4.34 Расстояние между пролетами стеллажей Для свободной работы с паллетой 800x1200 (продольная установка паллеты)	Ast mm	1585
4.35 Радиус Поворота Тележки	Wa mm	1167

## Производительность

5.2 Скорость Подъема Тележки, С Нагрузкой	strokes	13
5.2 Скорость Подъема Тележки, С Без Груза	strokes	13

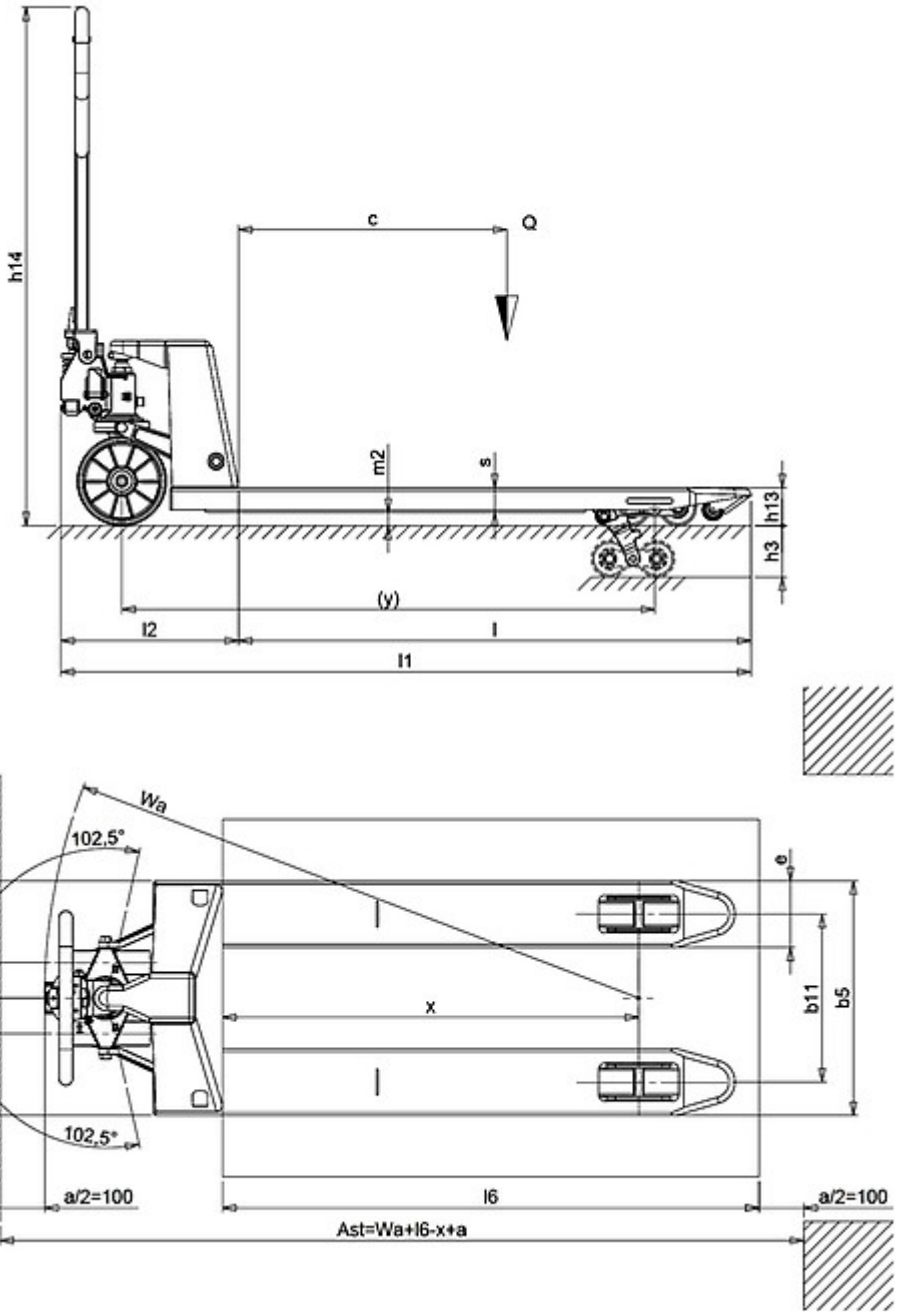

The information is aligned with the Data file at the time of download. Printed on 17/03/2020 (ID 575)

©2019 | PR INDUSTRIAL s.r.l. | All rights reserved | Image shown may not reflect actual package. Specifications subject to change without notice

